



User Guide

HP Thin Client

© Copyright 2018 HP Development Company, L.P.

Windows is either a registered trademark or trademark of Microsoft Corporation in the United States and/or other countries.

The information contained herein is subject to change without notice. The only warranties for HP products and services are set forth in the express warranty statements accompanying such products and services. Nothing herein should be construed as constituting an additional warranty. HP shall not be liable for technical or editorial errors or omissions contained herein.

First Edition: May 2018

Document Part Number: L18409-001

Product Notice

This user guide describes features that are common to most models. Some features may not be available on your computer.

Not all features are available in all editions or versions of Windows. Systems may require upgraded and/or separately purchased hardware, drivers, software or BIOS update to take full advantage of Windows functionality. Windows 10 is automatically updated, which is always enabled. ISP fees may apply and additional requirements may apply over time for updates. See <http://www.microsoft.com>.

To access the latest user guides, go to <http://www.hp.com/support>, and follow the instructions to find your product. Then select **User Guides**.

Software terms

By installing, copying, downloading, or otherwise using any software product preinstalled on this computer, you agree to be bound by the terms of the HP End User License Agreement (EULA). If you do not accept these license terms, your sole remedy is to return the entire unused product (hardware and software) within 14 days for a full refund subject to the refund policy of your seller.

For any further information or to request a full refund of the price of the computer, please contact your seller.

About This Guide





-  **WARNING!** Indicates a hazardous situation that, if not avoided, **could** result in bodily harm or loss of life.
 -  **CAUTION:** Indicates a hazardous situation that, if not avoided, **could** result in damage to equipment or loss of information.
 -  **IMPORTANT:** Indicates information considered important but not hazard-related (for example, messages related to property damage). A notice alerts the user that failure to follow a procedure exactly as described could result in loss of data or in damage to hardware or software. Also contains essential information to explain a concept or to complete a task.
 -  **NOTE:** Contains additional information to emphasize or supplement important points of the main text.
 -  **TIP:** Provides helpful hints for completing a task.
-

Table of contents

1 Hardware Reference	1
Product features	1
Components	2
Serial number location	3
Setup	3
Warnings and cautions	3
Connecting the AC power cord	4
Securing the thin client	4
Mounting and orienting the thin client	5
HP Quick Release mounting bracket	5
Supported mounting options	8
Supported orientation and placement	10
Non-supported placement	11
Routine thin client care	12
Hardware upgrades	12
Warnings and cautions	12
Removing the access panel	13
Removing and replacing the battery	14
2 Troubleshooting	16
Computer Setup (F10) Utility, BIOS Settings	16
Computer Setup (F10) Utility	16
Using Computer Setup (F10) Utility	16
Computer Setup—File	18
Computer Setup—Storage	19
Computer Setup—Security	20
Computer Setup—Power	21
Computer Setup—Advanced	22
Changing BIOS Settings from the HP BIOS Configuration Utility (HPBCU)	23
Updating or restoring a BIOS	25
Diagnostics and troubleshooting	26
LEDs	26
Wake-on LAN	26
Power-on sequence	27
Resetting the setup and power-on passwords	27
Power-on diagnostic tests	27

Interpreting POST diagnostic front panel LEDs and audible codes	28
Troubleshooting	29
Basic troubleshooting	29
Diskless (no-flash) unit troubleshooting	30
Configuring a PXE server	31
Using HP ThinUpdate to restore the image	31
Device management	32
Using HP PC Hardware Diagnostics (UEFI)	32
Downloading HP PC Hardware Diagnostics (UEFI) to a USB device	33
Power cord set requirements	33
General requirements	33
Japanese power cord requirements	34
Country-specific requirements	34
Statement of volatility	34
Available memory devices	34
Specifications	36
Appendix A Electrostatic discharge	37
Preventing electrostatic damage	37
Grounding methods	37
Appendix B Shipping information	38
Shipping preparation	38
Important service repair information	38
Appendix C Accessibility	39
Supported assistive technologies	39
Contacting support	39
Index	40

1 Hardware Reference

Product features



This guide describes the features of the HP t430 Thin Client. For more information about the hardware and software installed on this thin client, go to <http://www.hp.com/go/quickspecs> and search for this thin client.

Various options are available for your thin client. For more information about some of the available options, go to the HP website at <http://www.hp.com> and search for your specific thin client.

Components

For more information, go to <http://www.hp.com/go/quickspecs> and search for your specific thin client to find the QuickSpecs.

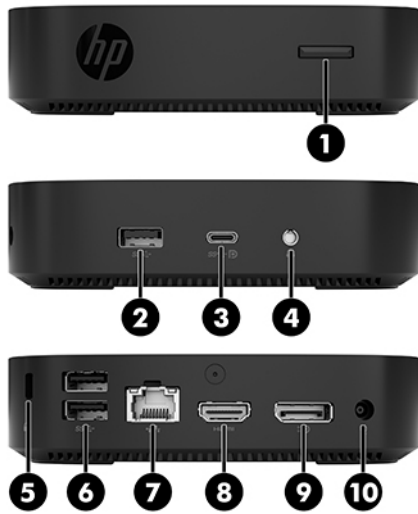

Item	Component	Item	Component
1	Power button	6	USB Type-A SuperSpeed ports (2)
2	USB Type-A SuperSpeed port	7	RJ-45 (network) jack
3	USB Type-C dual role DisplayPort alternate mode port	8	HDMI port
4	Headset jack	9	Dual-Mode DisplayPort port
5	Security cable slot	10	Power connector

Serial number location

Every thin client includes a unique serial number located as shown in the following illustration. Have this number available when contacting HP customer support for assistance.



Setup

Warnings and cautions

Before performing upgrades be sure to carefully read all of the applicable instructions, cautions, and warnings in this guide.

⚠ WARNING! To reduce the risk of personal injury or equipment damage from electric shock, hot surfaces, or fire:

Install the thin client in a location where children are unlikely to be present.

Disconnect the AC power cord from the AC outlet and allow the internal system components to cool before you touch them.

Do not plug telecommunications or telephone connectors into the network interface controller (NIC) receptacles.

Do not disable the AC power cord grounding plug. The grounding plug is an important safety feature.

Plug the AC power cord into a grounded (earthed) AC outlet that is easily accessible at all times.

⚠ WARNING! To reduce the risk of serious injury, read the *Safety & Comfort Guide* provided with your user guides. It describes proper workstation setup, and proper posture, health, and work habits for computer users. The *Safety & Comfort Guide* also provides important electrical and mechanical safety information. The *Safety & Comfort Guide* is available on the Web at <http://www.hp.com/ergo>.

⚠ WARNING! Energized parts inside.

Disconnect power to the equipment before removing the enclosure.

Replace and secure the enclosure before re-energizing the equipment.

⚠ CAUTION: Static electricity can damage the electrical components of the thin client or optional equipment. Before beginning the following procedures, be sure that you are discharged of static electricity by briefly touching a grounded metal object. See [Preventing electrostatic damage on page 37](#) for more information.

When the thin client is plugged into an AC power source, voltage is always applied to the system board. To prevent damage to internal components, you must disconnect the AC power cord from the power source before opening the thin client.

📝 NOTE: An optional Quick Release mounting bracket is available from HP for mounting the thin client to a wall, desk, or swing arm. When the mounting bracket is used, install the thin client with the I/O ports oriented towards the ground.

Connecting the AC power cord

1. Connect the power cord to the power adapter (1).
2. Connect the power cord to an AC outlet (2).
3. Connect the power adapter to the thin client (3).

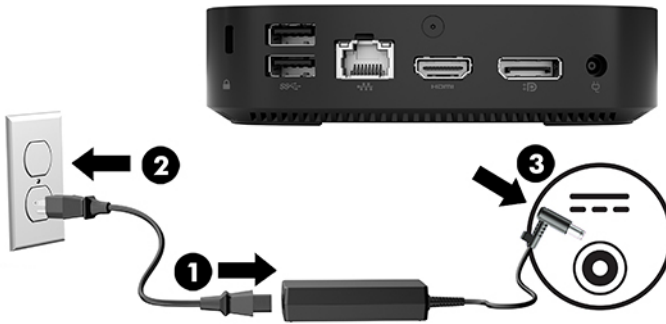

Securing the thin client

Thin clients are designed to accept a security cable. The security cable prevents unauthorized removal of the thin client and prevents access to the secure compartment. To order this option, go to the HP website at <http://www.hp.com> and search for your specific thin client.

1. Locate the security cable slot on the back panel.
2. Insert the security cable lock into the slot, and then use the key to lock it.



📝 NOTE: The security cable is designed to act as a deterrent, but it may not prevent the computer from being mishandled or stolen.

Mounting and orienting the thin client

HP Quick Release mounting bracket

An optional Quick Release mounting bracket is available from HP for mounting the thin client to a wall, desk, or swing arm. When the mounting bracket is used, install the thin client with the I/O ports oriented towards the ground.

This unit has four mounting points that can be accessed by removing the rubber feet on the bottom. These mounting points follow the VESA (Video Electronics Standards Association) standard, which provides industry-standard mounting interfaces for Flat Displays (FDs), such as flat panel monitors, flat displays, and flat TVs. The HP Quick Release mounting bracket connects to the VESA-standard mounting points, allowing you to mount the thin client in a variety of orientations.

 **NOTE:** When mounting to a thin client, use the 10 mm screws supplied with the HP Quick Release mounting bracket.



To use the HP Quick Release mounting bracket:

1. Lay the thin client upside down.
2. Remove the four rubber feet from the holes in the bottom of the thin client.

3. Position the HP Quick Release mounting bracket on the bottom of the thin client with the open end at the rear edge. Use four 10 mm screws included in the mounting device kit to attach the HP Quick Release mounting bracket, as shown in the following illustration.



4. Using four screws included in the mounting device kit, attach the other side of the HP Quick Release mounting bracket to the device to which you will mount the thin client. Make sure the release lever points upward.

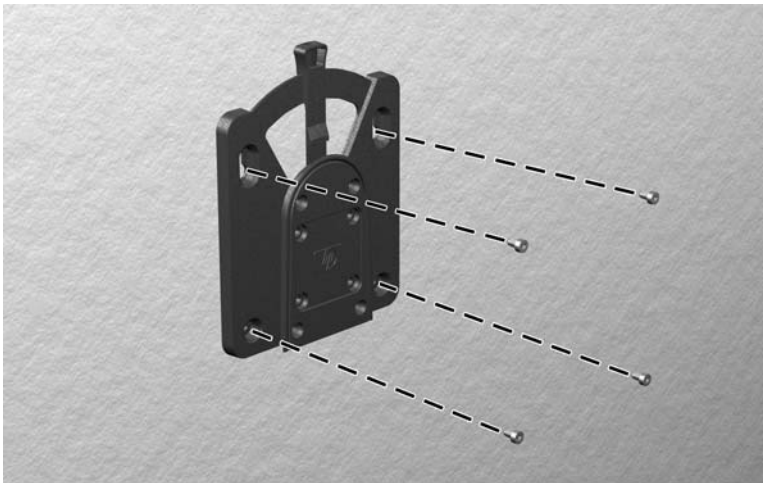

5. Slide the side of the mounting device attached to the thin client (1) over the other side of the mounting device (2) on the device on which you want to mount the thin client. An audible 'click' indicates a secure connection.



CAUTION: To ensure proper function of the HP Quick Release mounting bracket and a secure connection of all components, make sure both the release lever on one side of the mounting device and the rounded opening on the other side face upward.

NOTE: When attached, the HP Quick Release mounting bracket automatically locks in position. You only need to slide the lever to one side to remove the thin client.

Supported mounting options

The following illustrations demonstrate some of the supported mounting options for the mounting bracket.

- On the back of a monitor:



- On a wall:



- Under a desk:



Supported orientation and placement

CAUTION: You must adhere to the HP-supported orientation to ensure your thin clients function properly.

- HP supports the horizontal orientation for the thin client:



- The thin client may be placed under a monitor stand with at least 2.54 cm (1 in) clearance and 7.5 cm (3 in) for side cable routing:



Non-supported placement

HP does not support the following placements for the thin client:

⚠ CAUTION: Non-supported placement of thin clients could result in operation failure and/or damage to the devices.

Thin clients require proper ventilation to maintain operating temperature. Do not block the vents.

Install the thin client with the I/O ports oriented towards the ground.

Do not put thin clients in drawers or other sealed enclosures. Do not place a monitor or other object on top of the thin client. Do not mount a thin client between the wall and a monitor. Thin clients require proper ventilation to maintain operating temperatures.

- In a desk drawer:

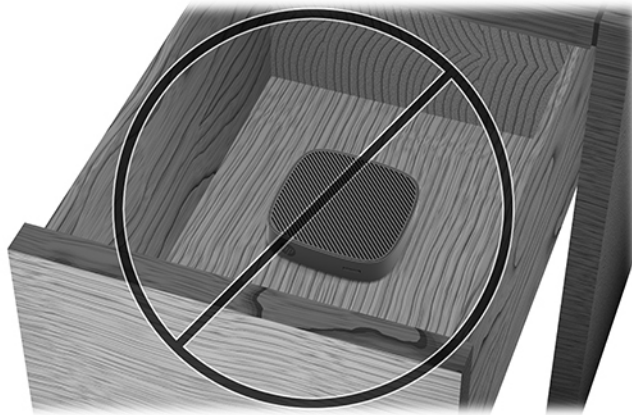

- With a monitor on the thin client:



Routine thin client care

Use the following information to properly care for your thin client:

- Never operate the thin client with the outside panel removed.
- Keep the thin client away from excessive moisture, direct sunlight, and extreme heat and cold. For information about the recommended temperature and humidity ranges for the thin client, go to <http://www.hp.com/go/quickspecs>.
- Keep liquids away from the thin client and keyboard.
- Turn off the thin client and wipe the exterior with a soft, damp cloth as needed. Using cleaning products may discolor or damage the finish.

Hardware upgrades

Warnings and cautions

Before performing upgrades be sure to carefully read all of the applicable instructions, cautions, and warnings in this guide.

⚠ WARNING! To reduce the risk of personal injury or equipment damage from electric shock, hot surfaces, or fire:

Disconnect power to the equipment before removing the enclosure. Energized and moving parts are inside.

Allow the internal system components to cool before you touch them.

Replace and secure the enclosure before re-energizing the equipment.

Do not plug telecommunications or telephone connectors into the network interface controller (NIC) receptacles.

Do not disable the AC power cord grounding plug. The grounding plug is an important safety feature.

Plug the AC power cord into a grounded (earthed) AC outlet that is easily accessible at all times.

⚠ WARNING! To reduce the risk of serious injury, read the *Safety & Comfort Guide* provided with your user guides. It describes proper workstation setup, and proper posture, health, and work habits for computer users. The *Safety & Comfort Guide* also provides important electrical and mechanical safety information. The *Safety & Comfort Guide* is available on the Web at <http://www.hp.com/ergo>.

⚠ CAUTION: Static electricity can damage the electrical components of the thin client or optional equipment. Before beginning the following procedures, be sure that you are discharged of static electricity by briefly touching a grounded metal object. See [Preventing electrostatic damage on page 37](#) for more information.

When the thin client is plugged into an AC power source, voltage is always applied to the system board. To prevent damage to internal components, you must disconnect the power cord from the power source before opening the thin client.

Removing the access panel

⚠ WARNING! To reduce the risk of personal injury or equipment damage from electric shock, hot surfaces, or fire, ALWAYS operate the thin client with the access panel in place. In addition to enhancing safety, the access panel may provide important instructions and identification information, which may be lost if the access panel is not used. DO NOT use any access panel except the one that is provided by HP for use with this thin client.

Before removing the access panel, be sure that the thin client is turned off and the AC power cord is disconnected from the AC outlet.

To remove the access panel:

1. Remove/disengage any security devices that prohibit opening the thin client.
2. Remove all removable media, such as USB flash drives, from the thin client.
3. Turn off the thin client properly through the operating system, and then turn off any external devices.
4. Disconnect the AC power cord from the AC outlet, and disconnect any external devices.

⚠ CAUTION: Regardless of the power-on state, voltage is always present on the system board as long as the system is plugged into an active AC outlet. You must disconnect the AC power cord to avoid damage to the internal components of the thin client.

5. Lay the unit flat on a stable surface with the top side up and the rear side facing you.
6. Use a Torx screwdriver to remove the Torx screw on the rear panel (1).

📝 NOTE: Be sure to save the screw to reattach to the access panel.

7. Insert a screwdriver into the opening of the security cable slot and push up carefully to raise the corner of the access panel (2).

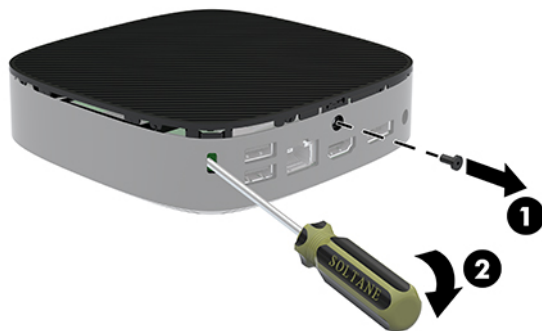

📝 NOTE: Be sure to save the screw to reattach the access panel.

8. Lift the right side of the access panel and carefully rotate the panel off the thin client (3).

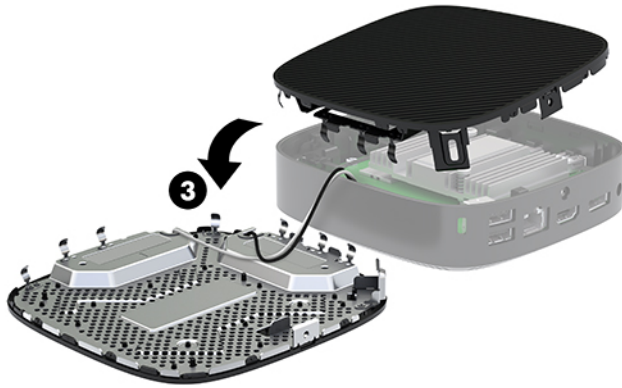

CAUTION: If the model includes a Wi-Fi adapter, be careful to avoid damage to the internal antenna.

Removing and replacing the battery

WARNING! Before removing the access panel, be sure that the thin client is turned off and the AC power cord is disconnected from the AC outlet.

To remove and replace the battery:

1. Remove the thin client access panel. See [Removing the access panel on page 13](#).

WARNING! To reduce risk of personal injury from hot surfaces, allow the internal system components to cool before you touch them.

2. Locate the battery on the system board.

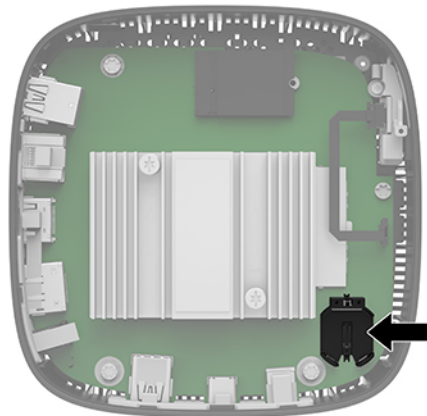

3. To release the battery from its holder, squeeze the metal clamp (1) that extends above one edge of the battery.

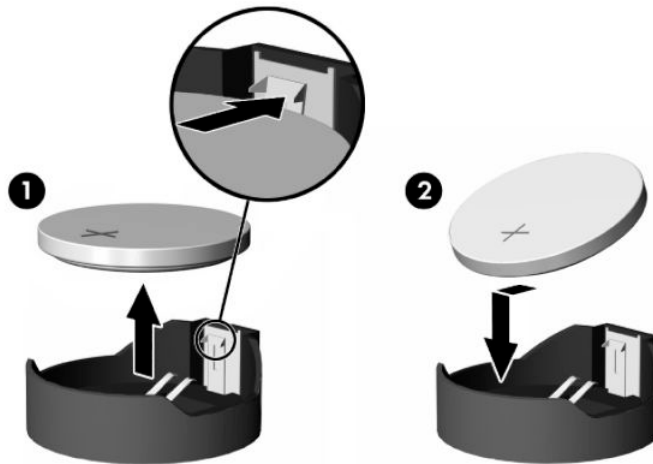

4. To insert the new battery, slide one edge of the replacement battery under the holder's lip (2) with the positive side up. Press the other edge down until the clamp snaps over the other edge of the battery.



5. Replace the access panel.

 **NOTE:** Be sure to secure the access panel with the Torx screw.

HP encourages customers to recycle used electronic hardware, HP original print cartridges, and rechargeable batteries. For more information about recycling programs, go to <http://www.hp.com> and search for “recycle.”

Icon	Definition
	Batteries, battery packs, and accumulators should not be disposed of together with the general household waste. In order to forward them to recycling or proper disposal, please use the public collection system or return them to HP, an authorized HP partner, or their agents.
	The Taiwan EPA requires dry battery manufacturing or importing firms, in accordance with Article 15 or the Waste Disposal Act, to indicate the recovery marks on the batteries used in sales, giveaways, or promotions. Contact a qualified Taiwanese recycler for proper battery disposal.

2 Troubleshooting

Computer Setup (F10) Utility, BIOS Settings

Computer Setup (F10) Utility

Use Computer Setup (F10) Utility to do the following:

- Change factory default settings.
- Set the system date and time.
- Set, view, change, or verify the system configuration, including settings for processor, graphics, memory, audio, storage, communications, and input devices.
- Modify the boot order of bootable devices such as solid-state drives or USB flash media devices.
- Select POST Messages Enabled or Disabled to change the display status of Power-On Self-Test (POST) messages. POST Messages Disabled suppresses most POST messages, such as memory count, product name, and other non-error text messages. If a POST error occurs, the error is displayed regardless of the mode selected. To manually switch to POST Messages Enabled during POST, press any key (except **F1** through **F12**).
- Enter the Asset Tag or property identification number assigned by the company to this computer.
- Enable the power-on password prompt during system restarts (warm boots) as well as during power-on.
- Establish a setup password that controls access to the Computer Setup (F10) Utility and the settings described in this section.
- Secure integrated I/O functionality, including the USB, audio, or embedded NIC, so that they cannot be used until they are unsecured.

Using Computer Setup (F10) Utility

Computer Setup can be accessed only by turning the computer on or restarting the system. To access the Computer Setup Utility menu, complete the following steps:

1. Turn on or restart the computer.
2. Press either **esc** or **F10** while the “Press the ESC key for Startup Menu” message is displayed at the bottom of the screen.

Pressing **esc** displays a menu that allows you to access different options available at startup.

 **NOTE:** If you do not press **esc** or **F10** at the appropriate time, you must restart the computer and again press **esc** or **F10** when the monitor light turns green to access the utility.

 **NOTE:** You can select the language for most menus, settings, and messages using the Language Selection option using the **F8** key in Computer Setup.

3. If you pressed **esc**, press **F10** to enter Computer Setup.
4. A choice of five headings appears in the Computer Setup Utility menu: File, Storage, Security, Power, and Advanced.

5. Use the arrow (left and right) keys to select the appropriate heading. Use the arrow (up and down) keys to select the option you want, and then press **enter**. To return to the Computer Setup Utility menu, press **esc**.
6. To apply and save changes, select **File > Save Changes and Exit**.
 - If you have made changes that you do not want applied, select **Ignore Changes and Exit**.
 - To reset to factory settings, select **Apply Defaults and Exit**. This option will restore the original factory system defaults.

 **CAUTION:** To reduce the risk of corrupting the CMOS, do not turn the computer power off while the BIOS is saving the Computer Setup (F10) changes. It is safe to turn off the computer only after exiting the F10 Setup screen.

Heading	Table
File	Computer Setup—File on page 18
Storage	Computer Setup—Storage on page 19
Security	Computer Setup—Security on page 20
Power	Computer Setup—Power on page 21
Advanced	Computer Setup—Advanced on page 22

Computer Setup—File



NOTE: Support for specific Computer Setup options may vary depending on the hardware configuration.

Option	Description
System Information	Lists: <ul style="list-style-type: none">• Product name• SKU number• System Board CT Number• Processor type• Processor speed• Processor stepping• Cache size (L1/L2)• Memory size• Integrated MAC• System BIOS• Chassis serial number• Asset tracking number
About	Displays copyright notice.
Flash System BIOS	Allows you to flash system BIOS from a USB recovery key. Allows you to do the following: <ul style="list-style-type: none">• Launch HpBiosUpdate• Update TPM FW• Update USB Type C PD FW
Set Time and Date	Allows you to set system time and date.
Default Setup	Allows you to do the following: <ul style="list-style-type: none">• Save Current Settings as Default• Restore Factory Settings as Default
Apply Defaults and Exit	Loads the original factory system configuration settings for use by a subsequent “Apply Defaults and Exit” action.
Ignore Changes and Exit	Exits Computer Setup without applying or saving any changes.
Save Changes and Exit	Saves changes to system configuration or default settings and exits Computer Setup.

Computer Setup—Storage

Option	Description
Device Configuration	<p>Lists all installed BIOS-controlled storage devices. When a device is selected, detailed information and options are displayed. The following options may be presented:</p> <p>Hard Disk: Size, model.</p>
Storage Options	<p>USB Storage Boot</p> <p>Allows you to set USB storage device default boot option in CSM/Legacy mode.</p>
Boot Order	<p>Allows you to do the following:</p> <ul style="list-style-type: none">• Specify the order in which EFI boot sources (such as an internal drive, USB hard drive, or USB optical drive) are checked for a bootable operating system image. Each device on the list may be individually excluded from or included for consideration as a bootable operating system source. EFI boot sources always have precedence over legacy boot sources.• Specify the order in which legacy boot sources (such as a network interface card, internal drive, or USB optical drive) are checked for a bootable operating system image. Each device on the list may be individually excluded from or included for consideration as a bootable operating system source.• Specify the order of attached hard drives. The first hard drive in the order will have priority in the boot sequence and will be recognized as drive C (if any devices are attached). <p>NOTE: You can use F5 to disable individual boot items, as well as disable EFI boot and/or legacy boot. MS-DOS drive lettering assignments may not apply after a non-MS-DOS operating system has started.</p> <p>Shortcut to Temporarily Override Boot Order</p> <p>To boot one time from a device other than the default device specified in Boot Order, restart the computer and press esc (to access the boot menu) and then F9 (Boot Order), or only F9 (skipping the boot menu) when the monitor light turns green. After POST is completed, a list of bootable devices is displayed. Use the arrow keys to select the preferred bootable device and press enter. The computer then boots from the selected non-default device for this one time.</p>

Computer Setup—Security



NOTE: Support for specific Computer Setup options may vary depending on the hardware configuration.

Option	Description
Setup Password	Allows you to set and enable a setup (administrator) password. NOTE: If the setup password is set, it is required to change Computer Setup options, flash the ROM, and make changes to certain Plug and Play settings under Windows®.
Power-On Password	Allows you to set and enable a power-on password. The power-on password prompt appears after a power cycle or reboot. If the user does not enter the correct power-on password, the unit will not boot.
Password Options (This selection appears only if a power-on password or setup password is set.)	Allows you to enable/disable: <ul style="list-style-type: none">• Stringent Password—When set, enables a mode in which there is no physical bypass of the password function. If enabled, removing the password jumper will be ignored.• Password Prompt on F9 & F12—Default is enabled.• Setup Browse Mode—Allows viewing, but not changing, the F10 Setup Options without entering setup password. Default is enabled.
Device Security	Allows you to set Device Available/Device Hidden (default is 'Device Available') for the following: <ul style="list-style-type: none">• System audio• Network controller• SSD
USB Security	Allows you to set Enabled/Disabled (default is Enabled) for: <ul style="list-style-type: none">• Side USB Ports<ul style="list-style-type: none">– USB Port 2– USB Port 4• Rear USB Ports<ul style="list-style-type: none">– USB Port 0– USB Port 1
Slot Security	Allows you to disable the M.2 PCI Express slot. Default is Enabled. <ul style="list-style-type: none">• Slot # - M.2 PCIe x1
Network Boot	Enables/disables the computer's ability to boot from an operating system installed on a network server. (Feature available on NIC models only; the network controller must be either a PCI expansion card or embedded on the system board.) Default is enabled.
System IDs	Allows you to set the following: <ul style="list-style-type: none">• Asset tag (18-byte identifier)—A property identification number assigned by the company to the computer.• Ownership tag (80-byte identifier)
System Security	Provides these options: <ul style="list-style-type: none">• Virtualization Technology (enable/disable)—Controls the virtualization features of the processor. Changing this setting requires turning the computer off and then back on. Default is disabled.• TPM Device—Lets you set the Trusted Platform Module as available or hidden.• TPM State—Select to enable the TPM.

Option	Description
	<ul style="list-style-type: none"> Clear TPM—Select to reset the TPM to an unowned state. After the TPM is cleared, it is also turned off. To temporarily suspend TPM operations, turn the TPM off instead of clearing it. <p>CAUTION: Clearing the TPM resets it to factory defaults and turns it off. You will lose all created keys and data protected by those keys.</p>
Secure Boot Configuration	<p>The options on this setup page are only for Windows 10 and other operating systems that support Secure Boot. Changing the default setting of the setup options on this page for operating systems that do not support secure boot may prevent the system from booting successfully.</p> <p>Legacy Support (enable/disable)—Enable or disable the legacy operating system support (Windows 10 IoT and HP Thin-Pro).</p> <p>Secure Boot (enable/disable)—When the Legacy Support set to Disable, this item can be set to Enable. This item is for Secure Boot flow control. Secure boot is possible only if system is run in user mode.</p> <p>Key Management</p> <ul style="list-style-type: none"> Clear Secure Boot Keys (Clear/Don't Clear). Lets you clear the Secure Boot Key. Key ownership (HP keys/Customer keys). Lets you change the keys of different owners. <p>Fast Boot (Enable/Disable)—Enable Fast Boot causes system boot by initializing a minimal set of devices which is required to launch the active boot option. This option has no effect for BBS boot options.</p>

Computer Setup—Power



NOTE: Support for specific Computer Setup options may vary depending on the hardware configuration.

Option	Description
OS Power Management	<p>Runtime Power Management (enable/disable)—Allows certain operating systems to reduce processor voltage and frequency when the current software load does not require the full capabilities of the processor. Default is enabled.</p> <p>Idle Power Savings (Extended/Normal)—Extended/Normal. Allows certain operating systems to decrease the processors power consumption when the processor is idle. Default is Extended.</p>
Hardware Power Management	<p>S5 Maximum Power Savings—Turns off power to all nonessential hardware when system is off to meet EUP Lot 6 requirement of less than 0.5 watt power usage. Default is disabled.</p>

Computer Setup—Advanced



NOTE: Support for specific Computer Setup options may vary depending on the hardware configuration.

Option	Heading
Power-On Options	<p>Allows you to set the following:</p> <ul style="list-style-type: none">• POST messages (enable/disable)—Default is disabled.• Press the ESC key for Startup Menu (Displayed/Hidden).• After Power Loss (off/on/previous state)—Default is Power off. Set this option as follows:<ul style="list-style-type: none">• Power off—Causes the computer to remain powered off when power is restored.• Power on—Causes the computer to power on automatically as soon as power is restored.• Previous state—Causes the computer to power on automatically as soon as power is restored, if it was on when power was lost. <p>NOTE: If you turn off power to the computer using the switch on a power strip, you will not be able to use the suspend/sleep feature or the Remote Management features.</p> <ul style="list-style-type: none">• POST Delay (in seconds)—Enabling this feature will add a user-specified delay to the POST process. This delay is sometimes needed for hard disks on some PCI cards that spin up so slowly that they are not ready to boot by the time POST is finished. The POST delay also gives you more time to select F10 to enter Computer (F10) Setup. Default is None.• Remote Wakeup Boot Source (Local Hard Drive/Remote Server). Allows you to set the source from which the computer gets its boot files when remotely awakened.
BIOS Power-On	<p>Allows you to set the computer to turn on automatically at a time you specify.</p>
Bus Options	<p>On some models, allows you to enable or disable the following:</p> <ul style="list-style-type: none">• PCI SERR# Generation. Default is enabled.• PCI VGA Palette Snooping, which sets the VGA palette snooping bit in PCI configuration space; only needed when more than one graphics controller is installed. Default is disabled.
Device Options	<ul style="list-style-type: none">• Integrated Graphics (Auto/Force)—Use this option to manage integrated (UMA) graphics memory allocation. The value you choose allocates memory permanently to graphics and is unavailable to the operating system. For example, if you set this value to 512M on a system with 2 GB of RAM, the system always allocates 512 MB for graphics and the other 1.5 GB for use by the BIOS and operating system. Default is Auto, which sets UMA memory by the memory installed on the platform as follows:<ul style="list-style-type: none">– 2 GB: 128 MB– 4 GB: 256 MBIf you select Force, the UMA Frame Buffer Size option displays, which lets you set the UMA memory size allocation between 128 MB and 512 MB.• S5 Wake on LAN (enable/disable)• Prompt for Power-On Password on Wake on LAN (enable/disable)• Num Lock State at Power-On (off/on). Default is off.
Option ROM Launch Policy	<p>Allows you to set the following:</p> <ul style="list-style-type: none">• Onboard NIC PXE Option ROMs (enable/disable)

Changing BIOS Settings from the HP BIOS Configuration Utility (HPBCU)

Some BIOS settings may be changed locally within the operating system without having to go through the F10 utility. This table identifies the items that can be controlled with this method.

For more information about the HP BIOS Configuration Utility, see the *HP BIOS Configuration Utility (BCU) User Guide* at www.hp.com.

BIOS setting	Default value	Other values
Language	English	Francais, Espanol, Deutsch, Italiano, Dansk, Suomi, Nederlands, Norsk, Portugues, Svenska, Japanese, Simplified Chinese
Set Time	00:00	00:00:23:59
Set Day	01/01/2011	01/01/2011 to current date
Update USB Type-C PD FW	Postpone	Now
TPM2.0 FW Tool-less Update	Disable	Enable
TPM Physical Present Check	Prompt	No Prompt
Default Setup	None	Save Current Settings as Default; Restore Factory Settings as Default
Apply Defaults and Exit	Disable	Enable
Stringent Password	Disable	Enable
USB Storage Boot	Before SSD	After SSD
UEFI Boot Sources	Windows Boot Manager	USB Floppy/CD; USB hard drive
Legacy Boot Sources	USB floppy/CD	Hard drive
System Audio	Enable	Disable
Network Controller	Enable	Disable
SSD	Enable	Disable
Side USB Ports	Enable	Disable
USB Port 2, 4	Enable	Disable
Rear USB Ports	Enable	Disable
USB Port 0, 1	Enable	Disable
Slot # M.2 PCIe x1	Enable	Disable
Network Boot	Enable	Disable
Asset Tracking Number		
Ownership Tag		
BIOS Update	Disable	Auto; Force
BIOS Image File Name		
Data Execution Prevention	Enable	Disable
Virtualization Technology	Disable	Enable
TPM Device	Available	Hidden

BIOS setting	Default value	Other values
TPM State	Enable	Disable
Clear TPM	Do not reset	Reset
Legacy Support	Enable	Disable (Note: The default value may vary, depending on the OS)
Secure Boot	Disable	Enable (Note: The default value may vary, depending on the OS)
Clear Secure Boot Keys	Don't Clear	Clear
Key Ownership	HP Keys	Custom Keys
Fast Boot	Disable	Enable (Note: The default value may vary, depending on the OS)
Setup Browse Mode	Enable	Disable
Password Prompt on F9 & F12	Enable	Disable
Runtime Power Management	Enable	Disable
Idle Power Savings	Extended	Normal
S5 Maximum Power Savings	Disable	Enable
S5 Wake on LAN	Enable	Disable
POST Messages	Disable	Enable
Press the ESC key for Startup Menu	Displayed	Hidden
After Power Loss	Off	On, Previous State
POST Delay (in seconds)	None	5, 10, 15, 20, 60
Remote Wakeup Boot Source	Local Hard Drive	Remote Server
Prompt for Power-On Password on Wake on LAN	Disable	Enable
Power on Sunday – Saturday	Disable	Enable
BIOS Power on Time (hh:mm)	00:00	00:00:23:59
PCI SERR# Generation	Enable	Disable
PCI VGA Palette Snooping	Disable	Enable
Integrated Graphics	Auto	Disable, Force
UMA Frame Buffer Size	256M	128M, 512M
Num Lock State at Power- On	Off	On
PXE Option ROMs	Enable	Disable

Updating or restoring a BIOS

HP Device Manager

HP Device Manager can be used to update the BIOS of a thin client. Customers can use a pre-built BIOS add-on or can use the standard BIOS upgrade package along with an HP Device Manager File and Registry template. For more information on HP Device Manager File and Registry templates, review the *HP Device Manager User Guide* found at www.hp.com/go/hpdm.

Windows BIOS flashing

You can use the BIOS Flash Update SoftPaq to restore or upgrade the system BIOS. Several methods for changing the BIOS firmware stored on your computer are available.

The BIOS executable is a utility designed to flash the System BIOS within a Microsoft Windows environment. To display the available options for this utility, launch the executable file under the Microsoft Windows environment.

You can run the BIOS executable with or without the USB storage device. If the system does not have a USB storage device installed, the system reboots after performing a BIOS update in a Microsoft Windows environment.

Linux BIOS flashing

All BIOS flashing under ThinPro 6.x and later utilizes tool-less BIOS updates, in which the BIOS updates itself.

Use the following comments to flash a Linux BIOS:

- `hptc-bios-flash ImageName`
Prepares the system to update the BIOS during the next restart. This command automatically copies the files into the correct location and prompts you to restart the thin client. This command requires that the tool-less update option in the BIOS settings is set to Auto. You can use `hpt-bios-cfg` to set the tool-less update option in the BIOS.
- `hptc-bios-flash -h`
Displays a list of options.

BitLocker Drive Encryption / BIOS Measurements

If you have Windows BitLocker Drive Encryption (BDE) enabled on your system, we recommend that you temporarily suspend BDE before updating the BIOS. You should also obtain your BDE recovery password or recovery PIN before suspending BDE. After you flash the BIOS, you can resume BDE.

To make a change to BDE, select Start > Control Panel > BitLocker Drive Encryption, select **Suspend Protection** or **Resume Protection**, and then select **Yes**.

As a general rule, updating the BIOS will modify measurement values stored in the Platform Configuration Registers (PCRs) of the system's security module. Temporarily disable technologies that use these PCR values to ascertain platform health (BDE is one such example) prior to flashing the BIOS. Once you update the BIOS, re-enable the functions and restart the system so that you can take new measurements.

BootBlock Emergency Recovery Mode

In the event of a failed BIOS update (for example if power is lost while updating), the System BIOS may become corrupted. BootBlock Emergency Recovery Mode detects this condition and automatically searches the root directory of the hard drive and any USB media sources for a compatible binary image. Copy the binary (.bin) file in the DOS Flash folder to the root of the desired storage device, and then power on the system. Once the recovery process locates the binary image, it attempts the recovery process. The automatic recovery continues until it successfully restores or updates the BIOS. If the system has a BIOS Setup password, you may need to use the Startup Menu / Utility submenu to flash the BIOS manually after providing the password.

Sometimes there are restrictions on which BIOS versions are allowed to be installed on a platform. If the BIOS that was on the system had restrictions, then only allowable BIOS versions can be used for recovery.

Diagnostics and troubleshooting

LEDs

LED	Status
Power LED is off	When the unit is plugged into the wall socket and the power LED is off, the unit is powered off. However, the network can trigger a Wake On LAN event in order to perform management functions.
Power LED is on	Displays during boot sequence and while the unit is on. During boot sequence, hardware initialization is processed and startup tests are performed on the following: <ul style="list-style-type: none">• Processor initialization• Memory detection and initialization• Video detection and initialization <p>NOTE: If one of the tests fails, the unit will simply stop, but the LED will stay on.</p> <p>NOTE: After the video subsystem is initialized, anything that fails will have an error message.</p>

NOTE: RJ-45 LEDs are located inside the RJ-45 connector on the top rear panel of the thin client. The LEDs are visible when the connector is installed. Blinking green indicates network activity, and amber indicates a 100MB speed connection.

Wake-on LAN

Wake-on LAN (WOL) allows a computer to be turned on or resumed from the sleep or hibernation state by a network message. You can enable or disable WOL in Computer Setup using the **S5 Wake on LAN** setting.

To enable or disable WOL:

1. Turn on or restart the computer.
2. Press either **esc** or **F10** while the “Press the ESC key for Startup Menu” message is displayed at the bottom of the screen.



NOTE: If you do not press **esc** or **F10** at the appropriate time, you must restart the computer and again press **esc** or **F10** when the monitor light turns green.

3. If you pressed **esc**, press **F10** to enter Computer Setup.
4. Navigate to **Advanced > Device Options**.
5. Set **S5 Wake on LAN** to either enabled or disabled.
6. Press **F10** to accept any changes.
7. Select **File > Save Changes and Exit**.



IMPORTANT: The **S5 Maximum Power Savings** setting can affect wake-on LAN. If you enable this setting, wake-on LAN is disabled. This setting is found in Computer Setup at **Power > Hardware Management**.

Power-on sequence

At power-on, the flash boot block code initializes the hardware to a known state, then performs basic power-on diagnostic tests to determine the integrity of the hardware. Initialization performs the following functions:

1. Initializes CPU and memory controller.
2. Initializes and configures all PCI devices.
3. Initializes video software.
4. Initializes the video to a known state.
5. Initializes USB devices to a known state.
6. Performs power-on diagnostics. For more information, see “Power-on diagnostic tests”.
7. The unit boots the operating system.

Resetting the setup and power-on passwords

You can reset the setup and power-on passwords as follows:

1. Turn off the computer and disconnect the power cord from the power outlet.
2. Remove the side access panel and the metal side cover.
3. Remove the password jumper from the system board header labeled PSWD/E49.
4. Replace the metal side cover and the side access panel.
5. Connect the computer to AC power, and then turn on the computer.
6. Turn off the computer and disconnect the power cord from the power outlet.
7. Remove the side access panel and the metal side cover.
8. Replace the password jumper.
9. Replace the metal side cover and the side access panel.

Power-on diagnostic tests

The Power-on diagnostics performs basic integrity tests of the hardware to determine its functionality and configuration. If a diagnostic test fails during hardware initialization the unit simply stops. There are no messages sent to video.



NOTE: You may try to restart the unit and run through the diagnostic tests a second time to confirm the first shutdown.

The following table lists the tests that are performed on the unit.

Table 2-1 Power-on diagnostic test

Test	Description
Boot Block Checksum	Tests boot block code for proper checksum value.
DRAM	Performs a simple write/read pattern test of the first 640k of memory.
Serial Port	Performs a simple verification test of the serial port to determine if ports are present.
Timer	Tests timer interrupt by using polling method.

Table 2-1 Power-on diagnostic test (continued)

Test	Description
RTC CMOS battery	Tests integrity of RTC CMOS battery.
NAND flash device	Tests for proper NAND flash device ID present.

Interpreting POST diagnostic front panel LEDs and audible codes

This section covers the front panel LED codes as well as the audible codes that may occur before or during POST that do not necessarily have an error code or text message associated with them.

 **WARNING!** When the computer is plugged into an AC power source, voltage is always applied to the system board. To reduce the risk of personal injury from electrical shock and/or hot surfaces, be sure to disconnect the power cord from the wall outlet and allow the internal system components to cool before touching.

 **NOTE:** Recommended actions in the following table are listed in the order in which they should be performed.

Not all diagnostic lights and audible codes are available on all models.

Activity	Beeps	Possible Cause	Recommended Action
White power LED is on.	None	Computer on.	None
White power LED flashes every two seconds.	None	Computer in Suspend to RAM mode (some models only) or normal Suspend mode.	No action required. Press any key or move the mouse to wake the computer.
Red power LED solid red.	None	Processor thermal protection activated: OR The heat sink assembly is not properly attached to the processor. OR The unit has vents blocked or is in a location where the ambient temperature is too high.	<ol style="list-style-type: none"> 1. Ensure that the computer air vents are not blocked and the processor cooling fan is plugged in and running, if equipped. 2. Contact an authorized reseller or service provider.
Red power LED flashes eight times, once every second, followed by a two-second pause.	None	Invalid ROM based on bad checksum.	<ol style="list-style-type: none"> 1. Reflash the system ROM with the latest BIOS image using the BIOS Recovery procedure. 2. Replace the system board.

Troubleshooting

Basic troubleshooting

If the thin client is experiencing operating problems or will not power on, review the following items.

Issue	Procedures
The thin client unit is experiencing operating problems.	Ensure that the following connectors are securely plugged into the thin client unit: Power connector, keyboard, mouse, network RJ-45 connector, display
The thin client unit does not power on.	<ol style="list-style-type: none">1. Verify that the power supply is good by installing it on a known working unit and testing it. If the power supply does not work on the test unit, replace the power supply.2. If the unit does not work properly with the replaced power supply, have the unit serviced.
The thin client unit powers on and displays a splash screen, but does not connect to the server.	<ol style="list-style-type: none">1. Verify that the network is operating and the network cable is working properly.2. Verify that the unit is communicating with the server by having the system administrator ping the unit from the server:<ul style="list-style-type: none">– If the thin client pings back, the signal was accepted and the unit is working. This indicates a configuration issue.– If the thin client does not ping back and the thin client does not connect to the server, re-image the unit.
There is no link or activity on the network RJ-45 LEDs or the LEDs do not illuminate blinking green after the thin client is turned on. (The network LEDs are located inside the RJ-45 connector on the top rear panel of the thin client. Indicator lights are visible when the connector is installed.)	<ol style="list-style-type: none">1. Verify that the network is not down.2. Make sure the RJ-45 cable is good by installing the RJ-45 cable onto a known working device—if a network signal is detected then the cable is good.3. Verify that the power supply is good by exchanging the power cable to the unit with a known working power supply cable and testing it.4. If network LEDs still do not light and you know the power supply is good, re-image the unit.5. If network LEDs still do not light, run the IP configuration procedure.6. If network LEDs still do not light, have the unit serviced.
A newly connected unknown USB peripheral does not respond or USB peripherals connected prior to the newly connected USB peripheral will not complete their device actions.	An unknown USB peripheral may be connected to and disconnected from to a running platform as long as you do not reboot the system. If problems occur, disconnect the unknown USB peripheral and reboot the platform.
Video does not display.	<ol style="list-style-type: none">1. Verify that the monitor brightness is set to a readable level.2. Verify that the monitor is good by connecting it to a known working computer, and ensure that its front LED turns green (assuming the monitor is Energy Star compliant). If the monitor is defective, replace it with a working monitor and repeat testing.3. Re-image the thin client unit and turn on the monitor again.4. Test the thin client unit on a known working monitor. If the monitor does not display video, replace the thin client unit.

Diskless (no-flash) unit troubleshooting

This section is only for those units that do not have ATA Flash capability. Because there is no ATA Flash in this model the boot priority sequence is:

- USB device
- PXE

1. When the unit boots, the monitor should display the following information.

Item	Information	Action
MAC Address	NIC portion of the system board is OK	If no MAC Address, the system board is at fault. Contact the Call Center for service.
GUID	General system board information	If no GUID information, the system board is at fault and should be replaced. Contact the Call Center for service for the bad system board.
Client ID	Information from server	If no Client ID information, there is no network connection. This may be caused by a bad cable, the server is down, or a bad system board. Contact the Call Center for service for the bad system board.
MASK	Information from server	If no MASK information, there is no network connection. This may be caused by a bad cable, the server is down, or a bad system board. Contact the Call Center for service for the bad system board.
DHCP IP	Information from server	If no DHCP IP information there is no network connection. This may be caused by a bad cable, the server is down, or a bad system board. Contact the Call Center for service for the bad system board.

If you are running in a Microsoft RIS PXE environment, go to step 2.

If you are running in a Linux environment, go to step 3.

2. If you are running in a Microsoft RIS PXE environment, press the **F12** key to activate the network service boot as soon as the DHCP IP information appears on the screen.

If the unit does not boot to the network, the server is not configured to PXE.

If you missed the F12 cue, the system will try to boot to the ATA flash that is not present. The message on the screen will read: **ERROR: Non-system disk or disk error. Replace and press any key when ready.**

Pressing any key will restart the boot cycle.

3. If you are running in a Linux environment, an error message will appear on the screen if there is no Client IP. **ERROR: Non-system disk or disk error. Replace and press any key when ready.**

Configuring a PXE server

 **NOTE:** All PXE software is supported by authorized service providers on a warranty or service contract basis. Customers who call the HP Customer Service Center with PXE issues and questions should be referred to their PXE provider for assistance.

Additionally, refer to the following:

– For Windows Server 2008 R2: <http://technet.microsoft.com/en-us/library/7d837d88-6d8e-420c-b68f-a5b4baeb5248.aspx>

– For Windows Server 2012: <http://technet.microsoft.com/en-us/library/jj648426.aspx>

The services listed below must be running, and they may be running on different servers:

1. Domain Name Service (DNS)
2. Remote Installation Services (RIS)

 **NOTE:** Active Directory DHCP is not required, but is recommended.

Using HP ThinUpdate to restore the image

HP ThinUpdate allows you to download images and add-ons from HP, capture an HP thin client image, and create bootable USB flash drives for image deployment.

HP ThinUpdate is preinstalled on some HP thin clients, and it is also available as an add-on at <http://www.hp.com/support> (search for the thin client model and see the **Drivers & software** section of the support page for that model).

- The Image Downloads feature lets you download an image from HP to either local storage or a USB flash drive. The USB flash drive option creates a bootable USB flash drive that can be used to deploy the image to other thin clients.
- The Image Capture feature lets you capture an image from an HP thin client and save it to a USB flash drive, which can be used to deploy the image to other thin clients.
- The Add-on Downloads feature lets you download add-ons from HP to either local storage or a USB flash drive.
- The USB Drive Management feature lets you do the following:
 - Create a bootable USB flash drive from an image file on local storage
 - Copy an .ibr image file from a USB flash drive to local storage
 - Restore a USB flash drive layout

You can use a bootable USB flash drive created with HP ThinUpdate to deploy an HP thin client image to another HP thin client of the same model with the same operating system.

System requirements

To create a recovery device for the purpose of reflashing or restoring the software image on the flash, you will need the following:

- One or more HP thin clients.
- USB flash device in the following size or larger:

- ThinPro: 8 GB
- Windows 10 IoT (if using the USB format): 32 GB

 **NOTE:** Optionally, you can use the tool on a Windows computer.

This restore method will not work with all USB flash devices. USB flash devices that do not show up as removable drive in Windows do not support this restore method. USB flash devices with multiple partitions generally do not support this restore method. The range of USB flash devices available on the market is constantly changing. Not all USB flash devices have been tested with the HP Thin Client Imaging Tool.

Device management

The thin client includes a license for HP Device Manager and has a Device Manager agent preinstalled. HP Device Manager is a thin-client optimized management tool used to manage the full life cycle of HP thin clients to include Discover, Asset Management, Deployment and Configuration. For more information on HP Device Manager, please visit www.hp.com/go/hpdm.

If you wish to manage the thin client with other management tools such as Microsoft SCCM or LANDesk, go to www.hp.com/go/clientmanagement for more information.

Using HP PC Hardware Diagnostics (UEFI)

HP PC Hardware Diagnostics is a Unified Extensible Firmware Interface (UEFI) that allows you to run diagnostic tests to determine whether the computer hardware is functioning properly. The tool runs outside the operating system so that it can isolate hardware failures from issues that are caused by the operating system or other software components.

When HP PC Hardware Diagnostics (UEFI) detects a failure that requires hardware replacement, a 24-digit Failure ID code is generated. This ID code can then be provided to support to help determine how to correct the problem.

 **NOTE:** To start diagnostics on a convertible computer, your computer must be in notebook mode and you must use the keyboard attached.

To start HP PC Hardware Diagnostics (UEFI), follow these steps:

1. Turn on or restart the computer, and quickly press `esc`.
2. Press `f2`.

The BIOS searches three places for the diagnostic tools, in the following order:

- a. Connected USB drive

 **NOTE:** To download the HP PC Hardware Diagnostics (UEFI) tool to a USB drive, see [Downloading HP PC Hardware Diagnostics \(UEFI\) to a USB device on page 33](#).

- b. Hard drive
- c. BIOS

3. When the diagnostic tool opens, select the type of diagnostic test you want to run, and then follow the on-screen instructions.

 **NOTE:** If you need to stop a diagnostic test, press `esc`.

Downloading HP PC Hardware Diagnostics (UEFI) to a USB device



NOTE: The HP PC Hardware Diagnostics (UEFI) download instructions are provided in English only, and you must use a Windows computer to download and create the HP UEFI support environment because only .exe files are offered.

There are two options to download HP PC Hardware Diagnostics to a USB device.

Download the latest UEFI version

1. Go to <http://www.hp.com/go/techcenter/pcdiags>. The HP PC Diagnostics home page is displayed.
2. In the HP PC Hardware Diagnostics section, select the **Download** link, and then select **Run**.

Download any version of UEFI for a specific product

1. Go to <http://www.hp.com/support>.
2. Select **Get software and drivers**.
3. Enter the product name or number.
4. Select your computer, and then select your operating system.
5. In the **Diagnostic** section, follow the on-screen instructions to select and download the UEFI version you want.

Power cord set requirements

The power supplies on some computers have external power switches. The voltage select switch feature on the computer permits it to operate from any line voltage between 100-120 or 220-240 volts AC. Power supplies on those computers that do not have external power switches are equipped with internal switches that sense the incoming voltage and automatically switch to the proper voltage.

The power cord set received with the computer meets the requirements for use in the country where you purchased the equipment.

Power cord sets for use in other countries must meet the requirements of the country where you use the computer.

General requirements

The requirements listed below are applicable to all countries:

1. The power cord must be approved by an acceptable accredited agency responsible for evaluation in the country where the power cord set will be installed.
2. The power cord set must have a minimum current capacity of 10A (7A Japan only) and a nominal voltage rating of 125 or 250 volts AC, as required by each country's power system.
3. The diameter of the wire must be a minimum of 0.75 mm² or 18AWG, and the length of the cord must be between 1.8 m (6 feet) and 3.6 m (12 feet).

The power cord should be routed so that it is not likely to be walked on or pinched by items placed upon it or against it. Particular attention should be paid to the plug, electrical outlet, and the point where the cord exits from the product.



WARNING! Do not operate this product with a damaged power cord set. If the power cord set is damaged in any manner, replace it immediately.

Japanese power cord requirements

For use in Japan, use only the power cord received with this product.

⚠ CAUTION: Do not use the power cord received with this product on any other products.

Country-specific requirements

Additional requirements specific to a country are shown in parentheses and explained below.

Country	Accrediting Agency	Country	Accrediting Agency
Australia (1)	EANSW	Italy (1)	IMQ
Austria (1)	OVE	Japan (3)	METI
Belgium (1)	CEBC	Norway (1)	NEMKO
Canada (2)	CSA	Sweden (1)	SEMKO
Denmark (1)	DEMKO	Switzerland (1)	SEV
Finland (1)	SETI	United Kingdom (1)	BSI
France (1)	UTE	United States (2)	UL
Germany (1)	VDE		

1. The flexible cord must be Type H05VV-F, 3-conductor, 0.75mm² conductor size. Power cord set fittings (appliance coupler and wall plug) must bear the certification mark of the agency responsible for evaluation in the country where it will be used.
2. The flexible cord must be Type SVT or equivalent, No. 18 AWG, 3-conductor. The wall plug must be a two-pole grounding type with a NEMA 5-15P (15A, 125V) or NEMA 6-15P (15A, 250V) configuration.
3. Appliance coupler, flexible cord, and wall plug must bear a "T" mark and registration number in accordance with the Japanese Dentori Law. Flexible cord must be Type VCT or VCTF, 3-conductor, 0.75 mm² conductor size. Wall plug must be a two-pole grounding type with a Japanese Industrial Standard C8303 (7A, 125V) configuration.

Statement of volatility

Thin Client products typically have three types of memory devices namely, RAM, ROM, and flash memory devices. Data stored in the RAM memory device will be lost once the power is removed from the device. RAM devices could be powered by main, aux, or battery power (power states are explained below). Therefore, even when the unit is not connected to an AC outlet, some of the RAM devices could be powered by battery power. Data stored in the ROM or flash memory devices will not be lost, even if the power to the device is removed. Manufacturers of flash devices usually specify a period of time (on the order of ten years) for data retention.

Definition of power states:

Main Power: Power available when the unit is turned on.

Aux or Standby power: Power available when the unit is in the Off state when the power supply is connected to an active AC outlet.

Battery Power: Power from a coin battery present in the Thin Client systems.

Available memory devices

The table below lists the available memory devices and their types per the models. Please note that the Thin Client systems do not use traditional hard drives with moving parts. Instead, they use flash memory devices with an IDE/ SATA front-end interface. Hence, the operating systems interface with these flash devices much

as they do to a regular IDE/ SATA hard drive. This IDE/ SATA flash device contains the image of the operating system. The flash device can only be written to by an administrator. A special software tool is required to format the flash devices and clear the data stored in them.

Use the following steps to update BIOS and use it to set the BIOS settings to factory default settings.

1. Download the latest BIOS for your model from the HP website.
2. Follow the instructions on the website to flash the BIOS.
3. Restart the system, and while system is powering on (after the HP splash screen, if displayed) press the **F10** key to enter the BIOS setup screen.
4. If the Ownership Tag or Asset Tag is set, manually clear it under **Security > System IDs**.
5. Select **File > Save Changes and Exit**.
6. To clear the Setup or Power-On passwords if set, and clear any other settings, power down the computer and remove the AC power cord and the computer hood.
7. Locate the (blue/green) two-pin password jumper on header E49 (labeled PSWD) and remove it.
8. Remove AC power, wait ten seconds until the unit AC power has drained out, and then press the clear CMOS button. (This is usually a yellow push button, labeled CMOS). After reconnecting AC power, the system will automatically boot to the operating system.
9. Replace the hood and AC power cord and turn the computer on. The passwords are now cleared and all other user-configurable, non-volatile memory settings are reset to their factory default values.
10. Re-enter the F10 setup utility.
11. Select **File > Default Setup > Restore Factory Settings as Default**. This will set the default settings back to the factory defaults.
12. Select **File > Apply Defaults and Exit**.
13. Shut down the computer, remove AC power cord, and then place the (blue/green) jumper back on header E49. Replace the computer hood and power cord.

Table 2-2 Available memory devices

Description	Location/Size	Power	Loss of data	Comments
System Boot ROM (BIOS)	SPI ROM (128 Mbit) on board			
System memory (RAM)	Onboard DRAM (2 GB/4 GB)	Main power	If main power is removed	Only S0/S3/S5/G3 ACPI states are supported
RTC (CMOS) RAM	RTC RAM is 256-byte RAM Memory in Intel embedded System on Chip (SoC)	Main/battery	If battery power is removed	
Keyboard/mouse (ROM)	2k bytes embedded in the super I/O controller (IT8613)	Main		
Keyboard/mouse (RAM)	256 bytes embedded in the super I/O controller (IT8613)	Main	If main power is removed	

Table 2-2 Available memory devices (continued)

Description	Location/Size	Power	Loss of data	Comments
LOM EEPROM	256 bytes embedded in LAN Chip	Aux		One Time programmable memory (OTP)
TPM	7206 bytes non-volatile memory	Main		

If you require additional information or need assistance, please contact James Smalls at 281-927-7489.

Specifications

For the latest specifications or additional specifications on the thin client, go to <http://www.hp.com/go/quickspecs/> and search for your specific thin client to find the QuickSpecs.

Item	Metric	U.S.
Dimensions		
Width	135 mm	5.32 in
Depth	135 mm	5.32 in
Height	32 mm	1.26 in
Weight	410 g	0.90 lbs
Operating temperature	10°C to 40°C	50°F to 104°F
Specifications are at sea level with altitude derating of 1° C/300m (1.8° F/1000ft) to a maximum of 3 Km (10,000 ft), with no direct, sustained sunlight. Upper limit may be limited by the type and number of options installed.		
Relative Humidity		
Condensing	20% to 80%	
Non-condensing	10% to 90%	
Specifications are at sea level with altitude derating of 1° C/300m (1.8° F/1000ft) to a maximum of 3 Km (10,000 ft), with no direct, sustained sunlight. Upper limit may be limited by the type and number of options installed.		
Power Supply		
Power output	45 W	
Operating voltage range	100 V ac to 240 V ac	
Rated line frequency	50 Hz to 60 Hz	

A Electrostatic discharge

A discharge of static electricity from a finger or other conductor may damage system boards or other static-sensitive devices. This type of damage may reduce the life expectancy of the device.

Preventing electrostatic damage

To prevent electrostatic damage, observe the following precautions:

- Avoid hand contact by transporting and storing products in static-safe containers.
- Keep electrostatic-sensitive parts in their containers until they arrive at static-free workstations.
- Place parts on a grounded surface before removing them from their containers.
- Avoid touching pins, leads, or circuitry.
- Always be properly grounded when touching a static-sensitive component or assembly.

Grounding methods

There are several methods for grounding. Use one or more of the following methods when handling or installing electrostatic-sensitive parts:

- Use a wrist strap connected by a ground cord to a grounded thin client chassis. Wrist straps are flexible straps of 1 megohm +/- 10 percent resistance in the ground cords. To provide proper grounding, wear the strap snug against the skin.
- Use heelstraps, toestraps, or bootstraps at standing workstations. Wear the straps on both feet when standing on conductive floors or dissipating floor mats.
- Use conductive field service tools.
- Use a portable field service kit with a folding static-dissipating work mat.

If you do not have any of the suggested equipment for proper grounding, contact an HP authorized dealer, reseller, or service provider.



NOTE: For more information about static electricity, contact an HP authorized dealer, reseller, or service provider.

B Shipping information

Shipping preparation

Follow these suggestions when preparing to ship the thin client:

1. Turn off the thin client and external devices.
2. Disconnect the AC power cord from the AC outlet, and then from the thin client.
3. Disconnect the system components and external devices from their power sources, and then from the thin client.
4. Pack the system components and external devices in their original packing boxes or similar packaging with sufficient packing material to protect them.



NOTE: For environmental nonoperating ranges, go to <http://www.hp.com/go/quickspecs>.

Important service repair information

In all cases, remove and safeguard all external options before returning the thin client to HP for repair or exchange.

In countries that support customer mail-in repair by returning the same unit to the customer, HP makes every effort to return the repaired unit with the same internal memory and flash modules that were sent.

In countries that do not support customer mail-in repair by returning the same unit to the customer, all internal options should be removed and safeguarded in addition to the external options. The thin client should be restored to the **original configuration** before returning it to HP for repair.

C Accessibility

HP designs, produces, and markets products and services that can be used by everyone, including people with disabilities, either on a stand-alone basis or with appropriate assistive devices. To access the latest information on HP accessibility, go to <http://www.hp.com/accessibility>.

Supported assistive technologies

HP products support a wide variety of operating system assistive technologies and can be configured to work with additional assistive technologies. Use the Search feature on your device to locate more information about assistive features.

 **NOTE:** For additional information about a particular assistive technology product, contact customer support for that product.

Contacting support

We are constantly refining the accessibility of our products and services and welcome feedback from users. If you have an issue with a product or would like to tell us about accessibility features that have helped you, please contact us at +1 (888) 259-5707, Monday through Friday, 6 a.m. to 9 p.m. North American Mountain Time. If you are deaf or hard-of-hearing and use TRS/VRS/WebCapTel, contact us if you require technical support or have accessibility questions by calling +1 (877) 656-7058, Monday through Friday, 6 a.m. to 9 p.m. North American Mountain Time.

 **NOTE:** Support is in English only.

Index

- A**
 - AC power cord connection 4
 - access panel
 - removing 13
 - accessibility 39
 - Advanced menu 22
 - audible codes 28
- B**
 - basic troubleshooting 29
 - battery, replacing 14
 - beep codes 28
 - BIOS
 - updating 25
 - BIOS Settings 16
- C**
 - cautions
 - electric shock 3, 12, 13
 - HP Quick Release mounting bracket 7
 - removing the battery 14
 - securing the power cable 4
 - static electricity 3, 12
 - thin client orientation 10
 - thin client placement 11
 - ventilation 11
 - changing BIOS settings 23
 - components 2
 - Computer Setup (F10) Utility 16
 - Computer Setup — Advanced menu 22
 - Computer Setup — File menu 18
 - Computer Setup — Power menu 21
 - Computer Setup — Security menu 20
 - Computer Setup — Storage menu 19
 - configuring a PXE server 31
 - country power cord set requirements 34
- D**
 - diagnostics and troubleshooting 26
 - dimensions 36
 - disabling/enabling Wake-on LAN (WOL) 26
 - diskless troubleshooting 30
- E**
 - electrostatic discharge 37
 - error
 - codes 28
- F**
 - File menu 18
 - flashing LEDs 28
- G**
 - grounding methods 37
- H**
 - hardware specifications 36
 - HP BIOS Configuration Utility (HPBCU) 23
 - HP PC Hardware Diagnostics (UEFI) using 32
 - HP Quick Release mounting bracket 5
 - HP ThinUpdate 31
 - humidity specifications 36
- I**
 - installation guidelines 3, 12
 - installing
 - HP Quick Release mounting bracket 5
 - security cable 4
 - thin client onto HP Quick Release mounting bracket 5
- J**
 - Japanese power cord requirements 34
- L**
 - LEDs 26
 - blinking power 28
- M**
 - M.2 storage module, removing 38
 - memory devices available 34
 - mounting options
 - on back of monitor stand 8
 - on wall 8
 - under desk 8
- N**
 - non-supported placements
 - in a drawer 11
 - under a monitor 11
- O**
 - options 1, 4
 - orientation, horizontal 10
- P**
 - passwords 27
 - power cord set requirements 33
 - country specific 34
 - Power menu 21
 - power output specifications 36
 - power supply specifications 36
 - power-on diagnostic tests 27
 - power-on sequence 27
 - preventing electrostatic damage 37
 - PXE server 31
- Q**
 - Quick Release mounting bracket 5
- R**
 - recycling 15
 - relative humidity specifications 36
 - removing
 - access panel 13
 - battery 14
 - M.2 storage module 38
 - USB flash drive 38
 - replacing
 - battery 14
 - resetting passwords 27
 - routine care 12

S

- security cable, installing 4
- Security menu 20
- serial number location 3
- service repair 38
- shipping preparation 38
- specifications
 - dimensions 36
 - hardware 36
 - humidity 36
 - power output 36
 - power supply 36
 - relative humidity 36
 - temperature 36
 - thin client 36
- Statement of volatility 34
- Storage menu 19
- support, contacting 39
- supported assistive technologies 39
- supported mounting options 8
- supported orientation
 - horizontal 10
- supported placement
 - under monitor stand 10

T

- temperature specifications 36
- troubleshooting 16, 29

U

- updating a BIOS 25
- USB flash drive, removing 38
- using HP ThinUpdate to restore the image 31

W

- Wake-on LAN (WOL) 26
- warnings
 - burn 3, 12, 14
 - electric shock 3, 12, 13, 14
 - grounding plug 3, 12
 - NIC receptacles 3, 12
- websites
 - HP 1